

75 μ m InGaAs PD TO-CAN

Model: AP-I0917T0075TO46-BL-X



Features:

- Wide dynamic range
- High Responsibility
- Low Dark Current
- Standard TO46 package

Product Specifications:

Absolute Maximum Ratings

Parameter	Symbol	Min	Max	Unit
Operation Temperature Range	T _{OP}	-40	85	°C
Storage Temperature Range	T _{stg}	-40	85	°C
Reverse Voltage	V _R		30	V
Forward Current	I _F		10	mA
Soldering temperature(<10sec)	S _{temp}		260	°C

Electrical/Optical Characteristics (25°C)

Parameter	Symbol	Test Conditions	Min	Typ	Max	Unit
Active Area	Φ	—	—	75	—	μ m
Optical Wavelength Range	λ	—	900	—	1700	nm
Saturated Optical Power	P _s	V _R = 0 V	3	—	—	dBm
Dark Current	I _d	V _R = -5 V	—	—	0.6	nA
Responsibility	Resp	V _R = -5 V, λ =1310nm	0.85	—	—	A/W
		V _R = -5 V, λ =1550nm	0.90	—	—	
-3dBm Bandwidth	BW	R _L = 50 Ω	2.00	—	—	GHz
Capacitance	C _t	V _R = -5 V, f=1MHz	—	—	0.7	PF

Outline Drawings (in mm)

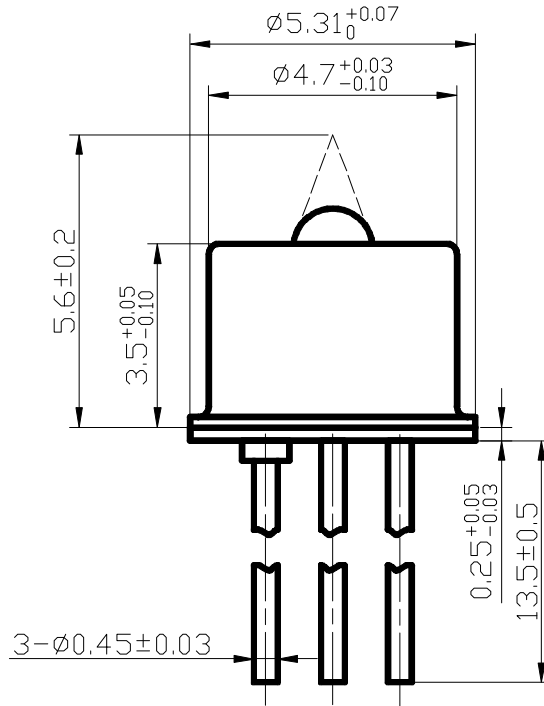

PIN-OUT

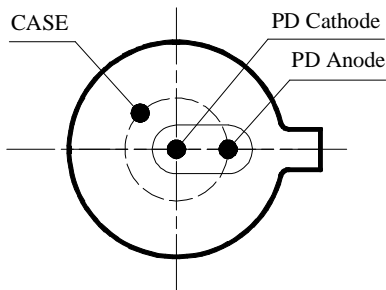

Type A (Bottom view)

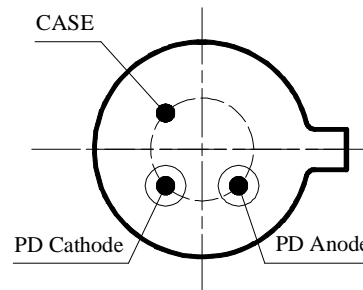

Type B (Bottom view)

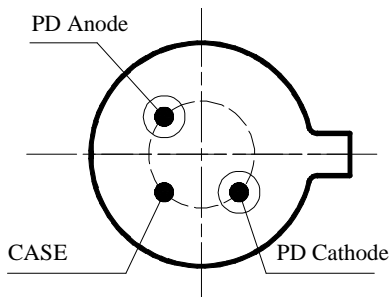

Type C (Bottom view)



Ordering information:

AP-I0917T0075TO46-BL-X

X="A" PIN-OUT="Type A", or "B" PIN-OUT="Type B", or "C" PIN-OUT="Type C"

BL=TO52 ball lens cap

Precaution:

- (1) The modules should be handled in the same manner as ordinary semiconductor device to prevent the electro-static damages. For safety keeping and carrying, the modules should be packaged with ESD proof material. TO assemble the modules on PCB, the workbench, the soldering iron and the human body should be grounded.
- (2) Please pay special attention to the atmosphere condition because the dew on the module may cause some electrical damages.
- (3) Under such a strong vibration environment as in automobile, the performance and reliability are not guaranteed.